

F 型矩形连接器

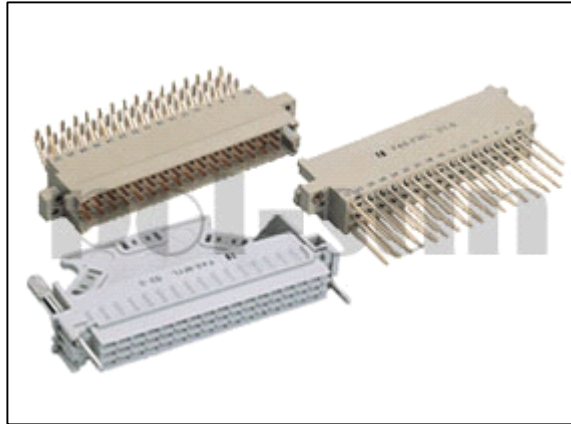

产品简介

F 型系列接插件是高可靠、接触稳定的新颖电连接器，其技术指标及外形安装尺寸符合 IEC603—F 标准和 DIN41612 本专业准，该系列接插件的品种规格有绕接式、焊接式、电缆式和压接式等，产品通用性强，能与国外同类产品互换，并可据用户要求，变换接触件的配置及插座端形式来满足不同要求的印制板连接，使用方便。

技术性能

工作温度: $-55^{\circ}\text{C} \sim +125^{\circ}\text{C}$
 相对温度: $40 \pm 2^{\circ}\text{C}$ 达 $(93 \pm 2/3)\%$
 工作气压: $101\text{Pa} \sim 6.7\text{Pa}$
 振动: $5 \sim 500\text{HZ}$, 100m/s^2
 碰撞: $10 \sim 40$ 次/min, 250m/s^2

工作电流	工作电压	接触电阻	机械寿命
4A	300V	$\leq 8\text{M}\Omega$	500cycles

工作环境	耐电压	绝缘电阻
正常条件下	2000V	$\geq 1000\text{M}\Omega$
高温条件下	500V	$\geq 500\text{M}\Omega$
潮湿条件下	500V	$\geq 50\text{M}\Omega$
低气压条件下	200V	—

型号命名方法

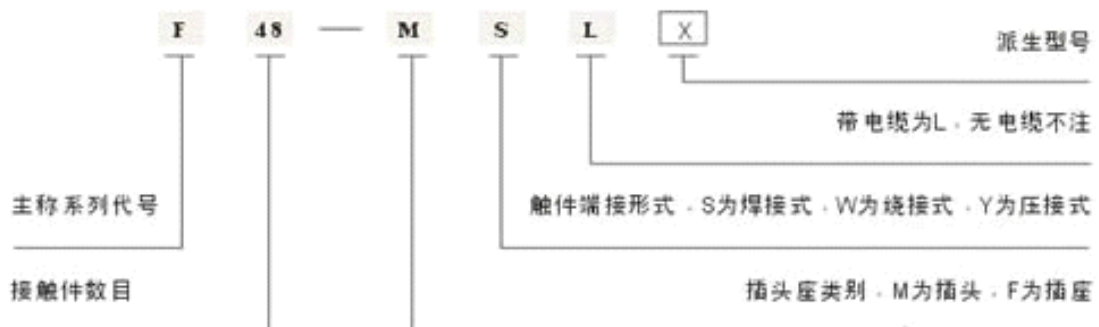

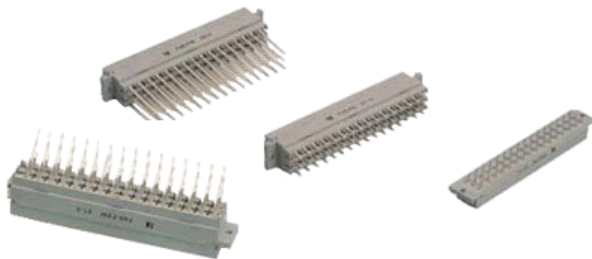
F48 插头

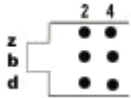
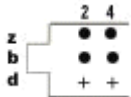
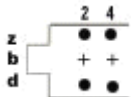
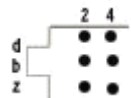
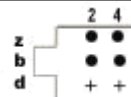
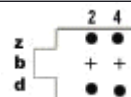
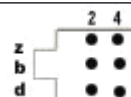
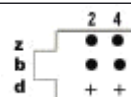
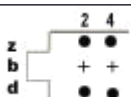
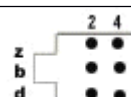
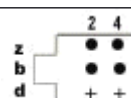
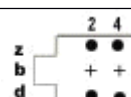
型号	芯数	芯数分布图	参考编号
F48-FW	48		09 06 248 6821
F32-FW	32		09 06 232 6821
F32-FW	32		09 06 232 6831
F48-FSa(b)	48		09 06 248 6835
F32-FSa(b)	32		09 06 232 6835
F32-FSa(b)	32		09 06 232 6845
F48-FSW	48		09 06 248 6836
F32-FSW	32		09 06 232 6846
F32-FSW	32		09 06 232 6836
F48-FS	48		
F32-FS	32		
F32-FS	32		

外形图

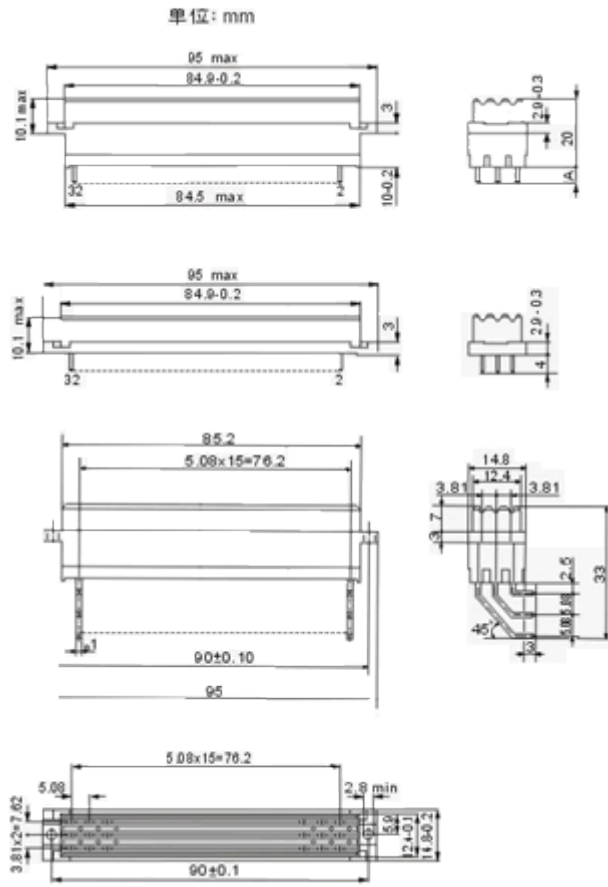

印制板开孔尺寸

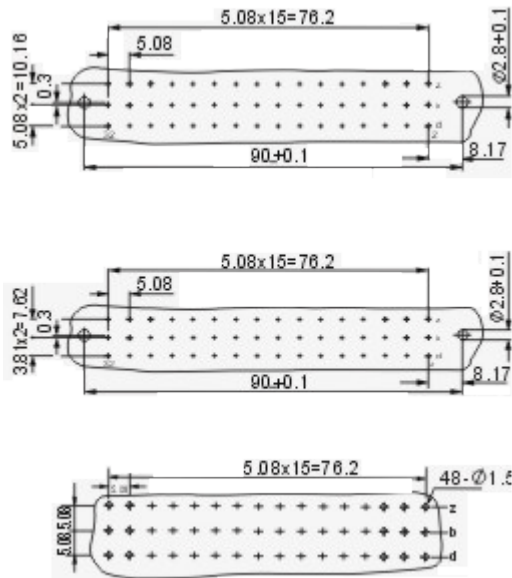

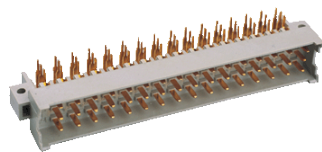
F48-MS 插头

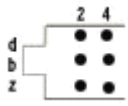
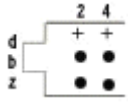
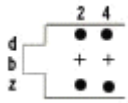
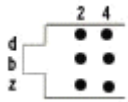
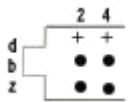
型号	芯数	芯数分布图	参考编号
F-48-MS	48		09 06 148 6901
F32-MS	32		09 06 132 6901
F32-MS-1	32		09 06 132 6931
F48-MS	47+1		09 06 148 6921
F32-MS	31+1		09 06 132 6921

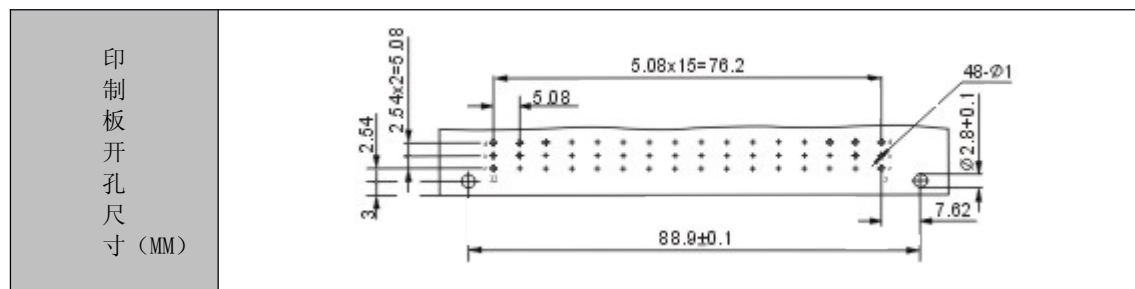

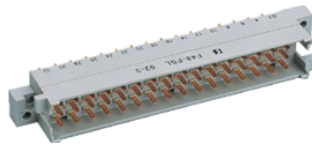
F48-FSL 插座

<p style="text-align: center;">外形图</p>	<p style="text-align: center;">单位: mm</p>		
<p style="text-align: center;">印制板开孔尺寸</p>			
<p style="text-align: center;">型号</p>	<p style="text-align: center;">芯数</p>	<p style="text-align: center;">芯数分布图</p>	<p style="text-align: center;">参考编号</p>
<p style="text-align: center;">F48-FSL</p>	<p style="text-align: center;">48</p>		<p style="text-align: center;">09 06 048 2905</p>
<p style="text-align: center;">F32-FSL</p>	<p style="text-align: center;">32</p>		<p style="text-align: center;">09 06 032 2905</p>



F48-MSL 插头



型号	芯数	芯数分布图	参考编号
F48-MSL	48		09 06 248 6823
F32-MSL	32		09 06 232 6823
F32-MSL	32		09 06 232 6843

外形图

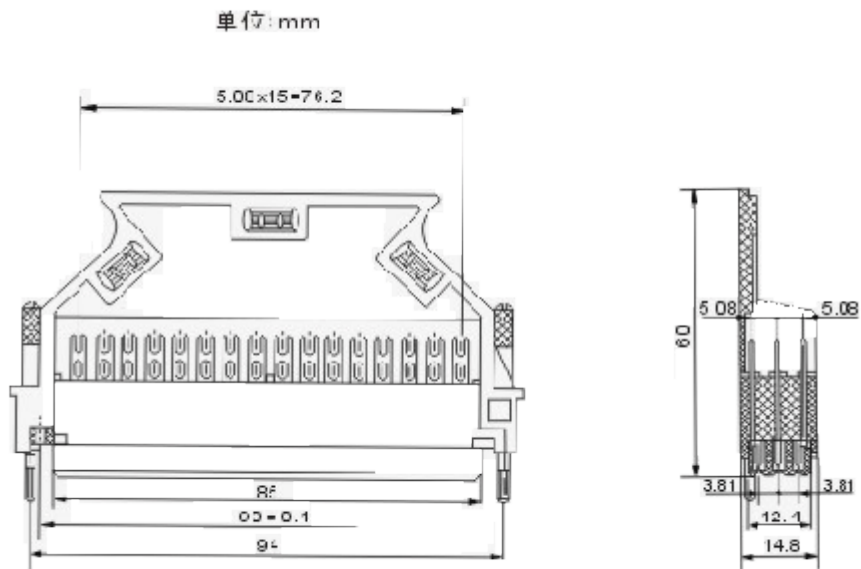

F48-MYL 插座

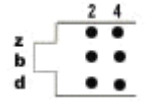
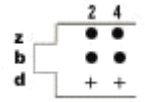
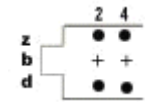
型号	芯数	芯数分布图	参考编号
F48-MSL	48		09 06 248 6823
F32-MSL	32		09 06 232 6823
F32-MSL	32		09 06 232 6843

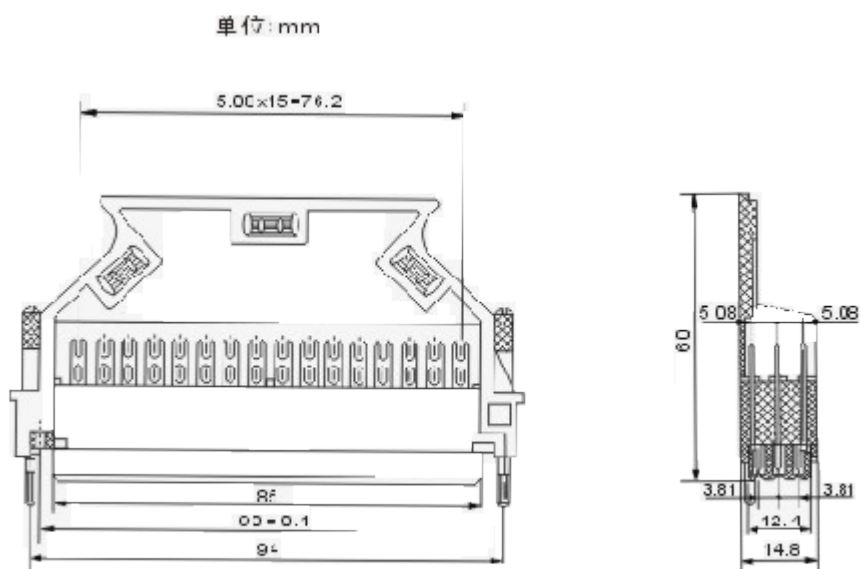
外形图

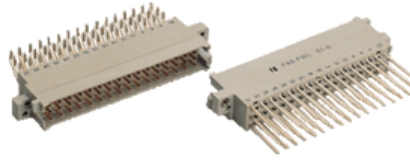
F48-FWL 插头座

型号	芯数	芯数分布图	参考编号
F48-FWL	48		09 06 248 2903
F32-FWL	32		09 06 032 2903
F48-FSWL	48		

外形图
